

MONTAGE BADMEESTERSTOEL

<https://wszystkodobasenow.pl/krzeslo-ratownika-z-tworzywa>

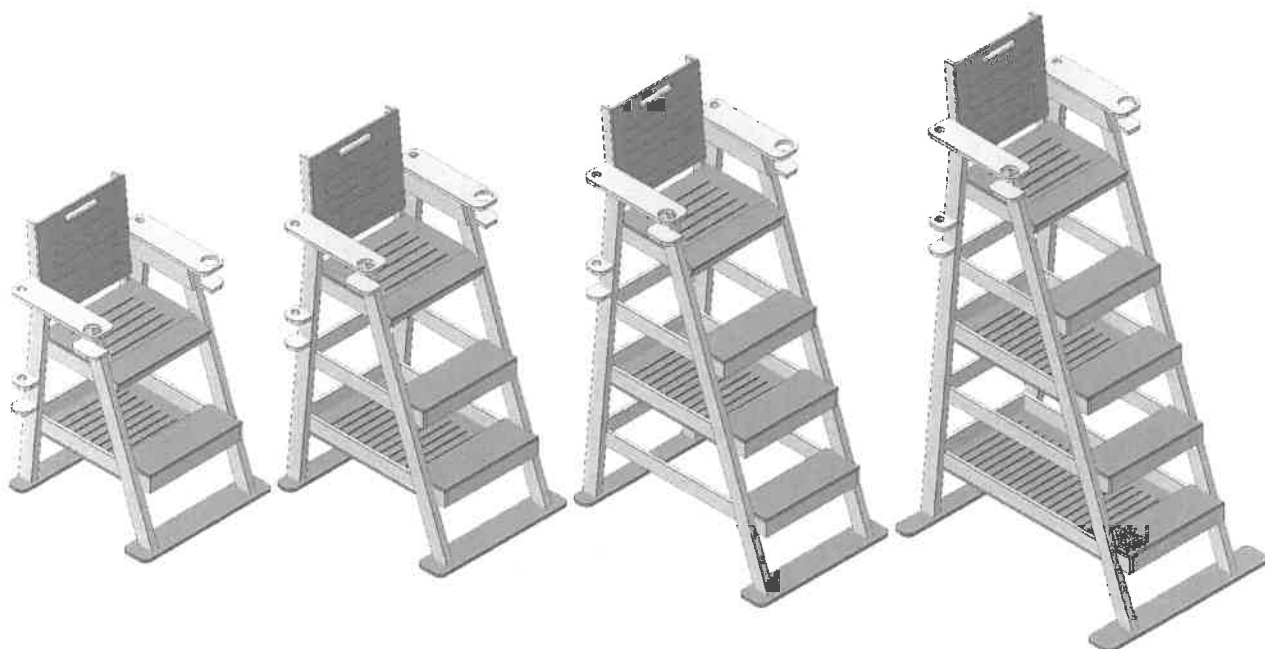

OVERZICHT ONDERDELEN

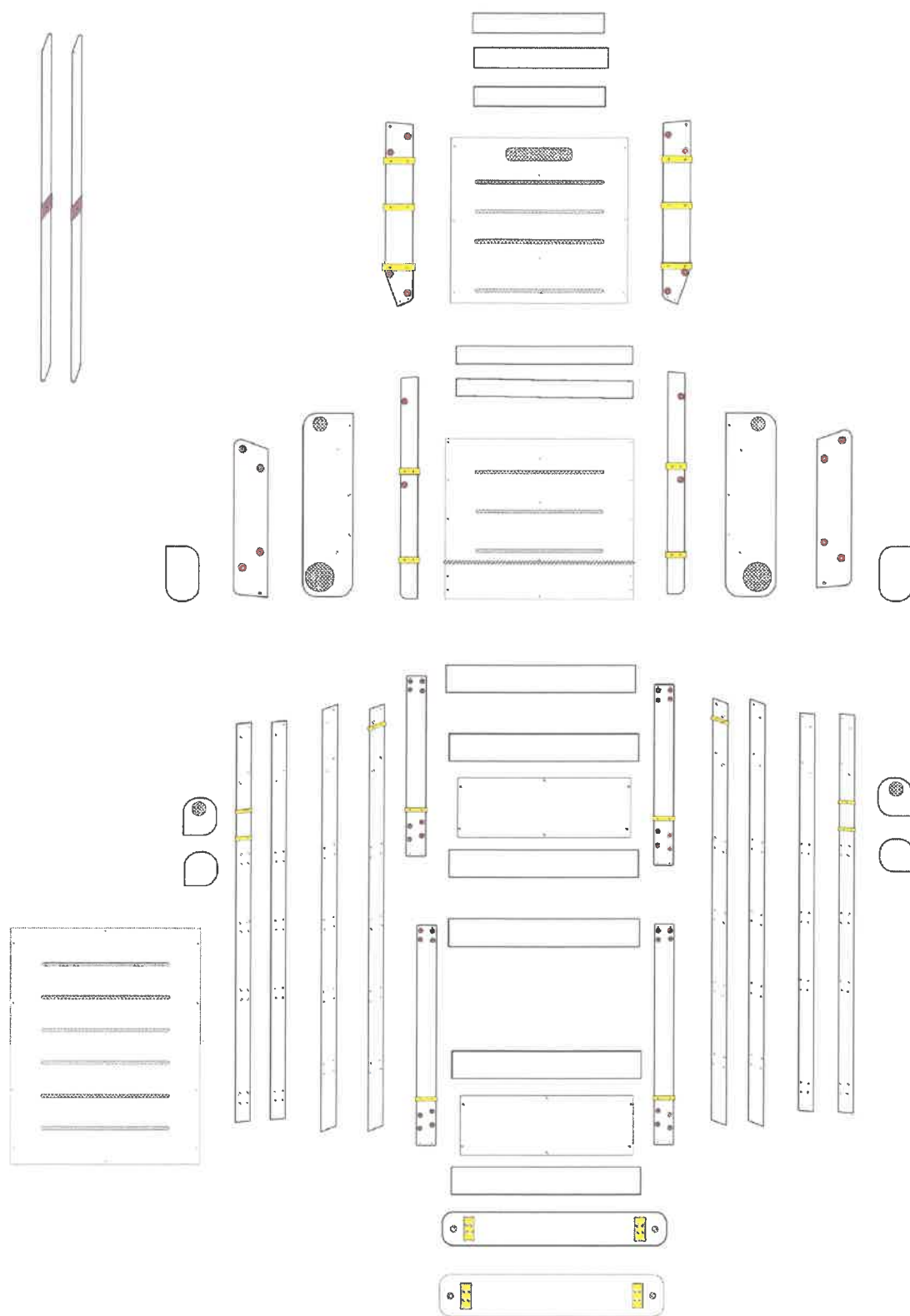

Overzicht is van een 2 treden badmeesterstoel.

Afhankelijk van Meer of minder treden komt er van het onderste deel extra onderdelen.

Overzicht bevestigingsmaterialen:

Bout M6 x 50mm	= 63 stuks
Bout M6 x 35mm	= 4 stuks
Bout M6 x 16mm	= 1 stuk
Slagmoeren M6	= 68 stuks
Schroeven 4 x 50	= 168 stuks
Vleugelmoer M6	= 2 stuks
Silicon vet tube 5mg	= 1 stuk

Gereedschap :

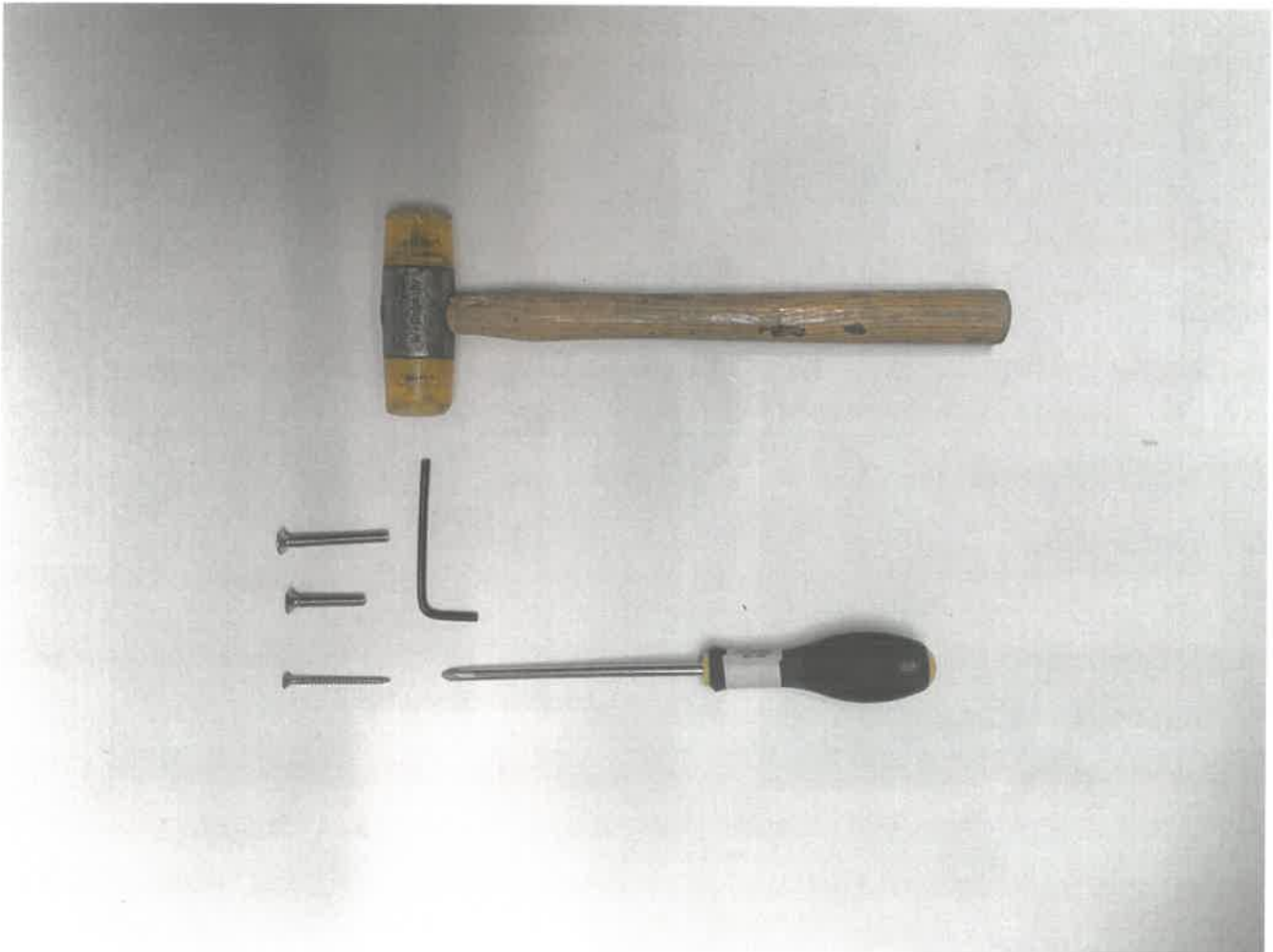

Montage :
Rugleuning

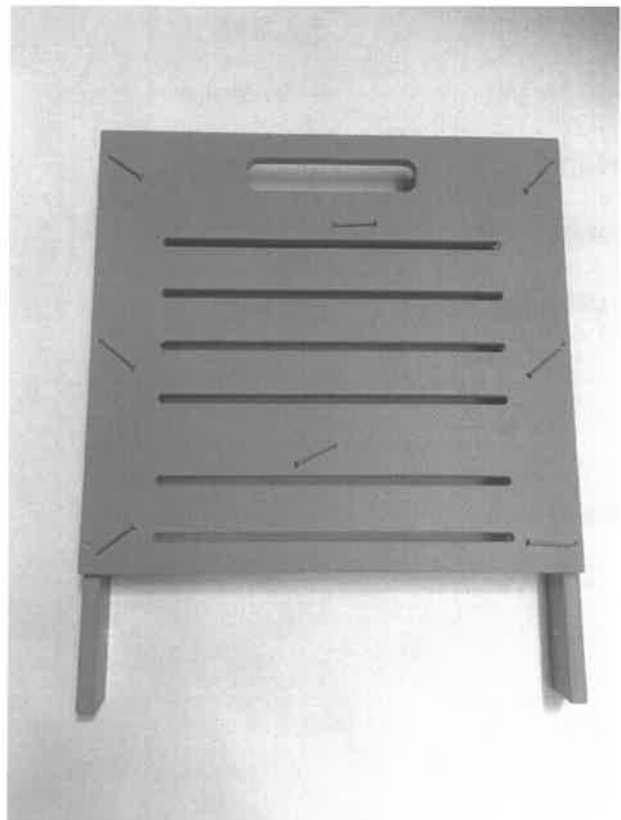
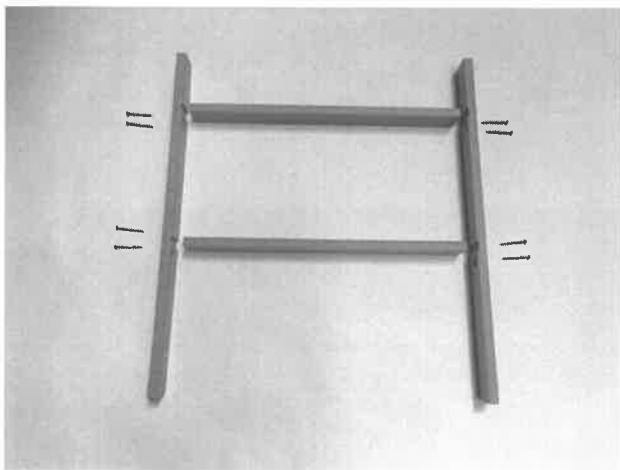

Montage zit :

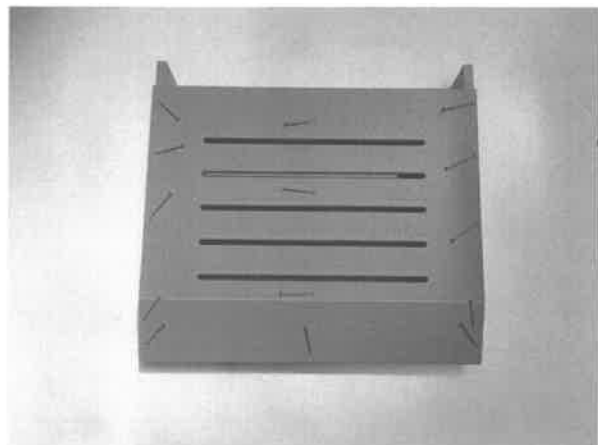
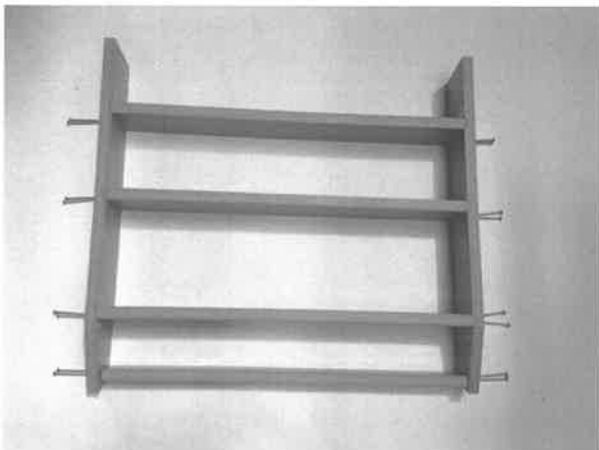

Montage trede 1 (bovenaan)

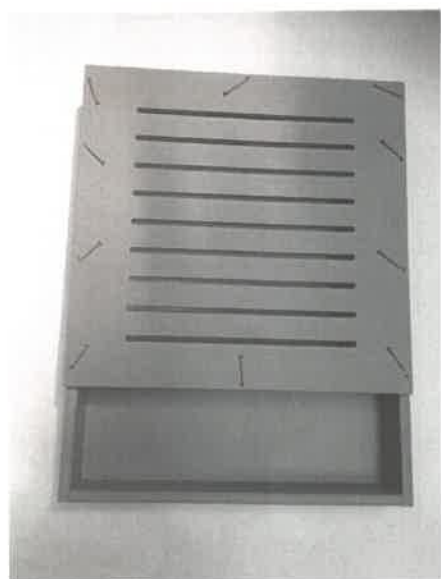
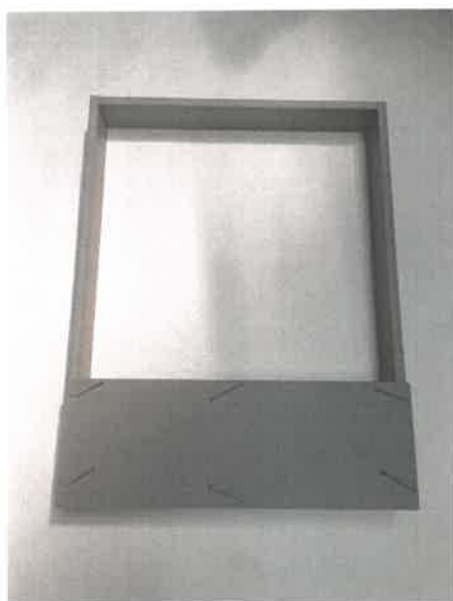
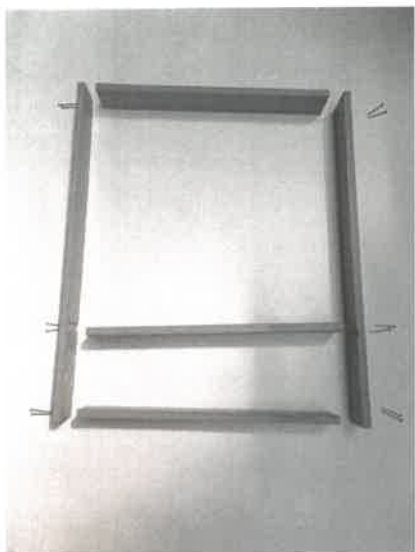

Montage poten voor

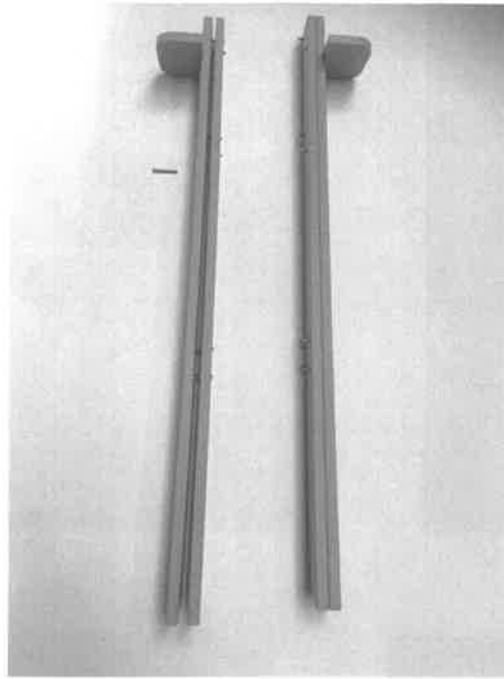
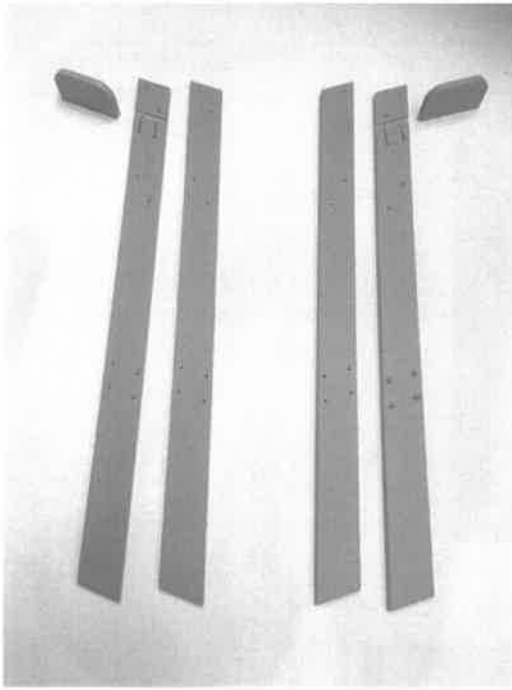

Montage poten achteraan

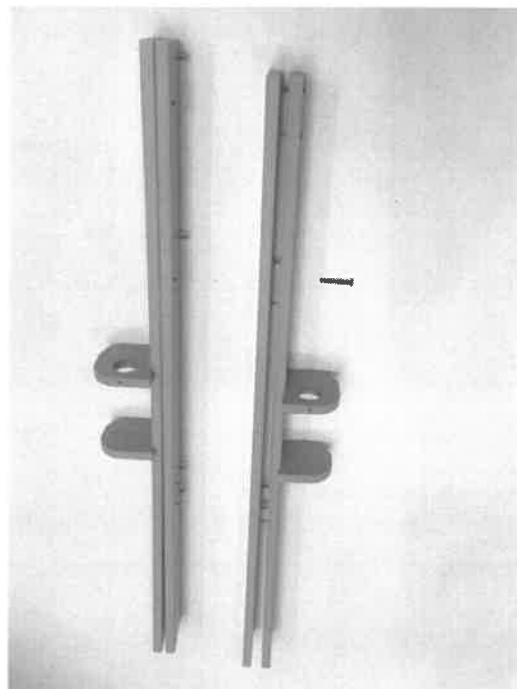
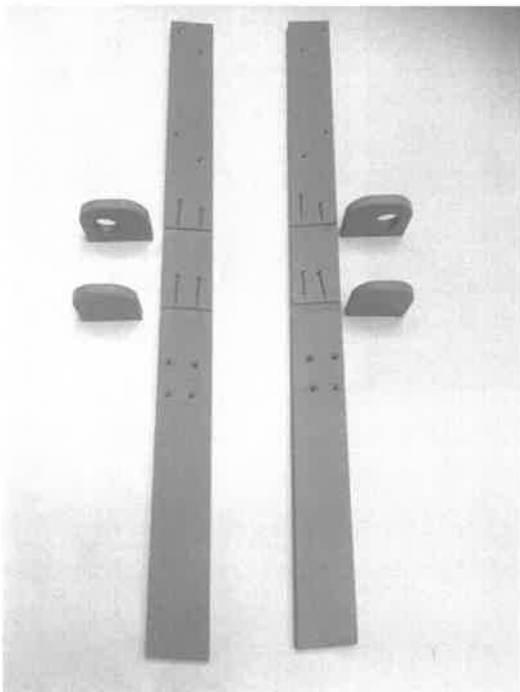

Montage voor en achterpoten aan zitvlak en trede(n)

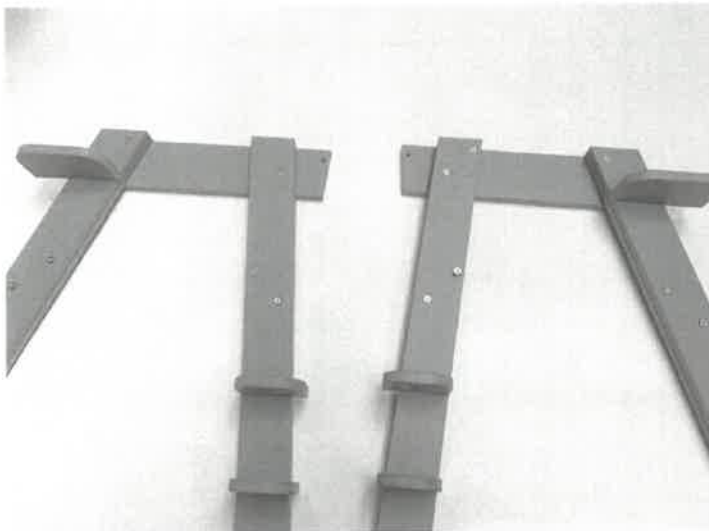
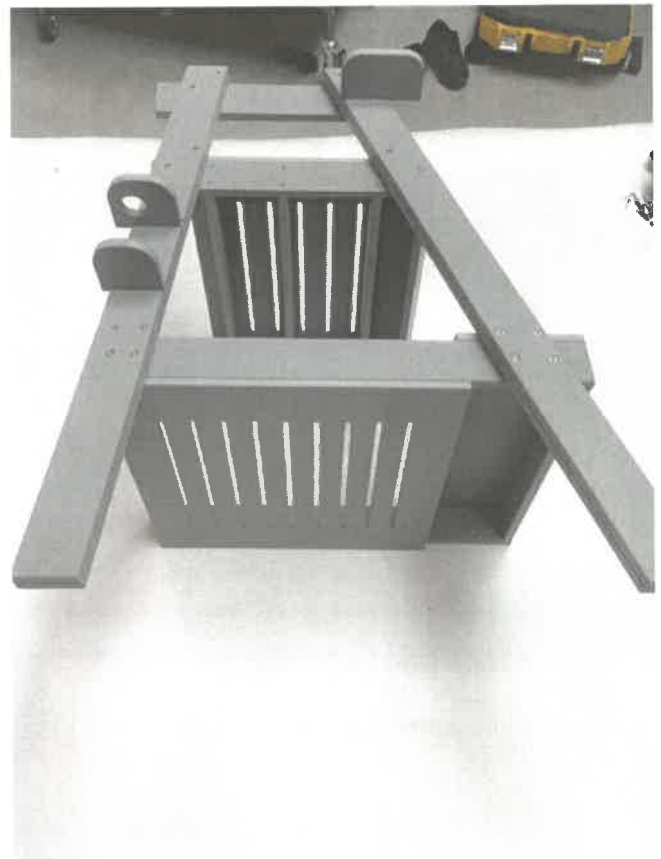
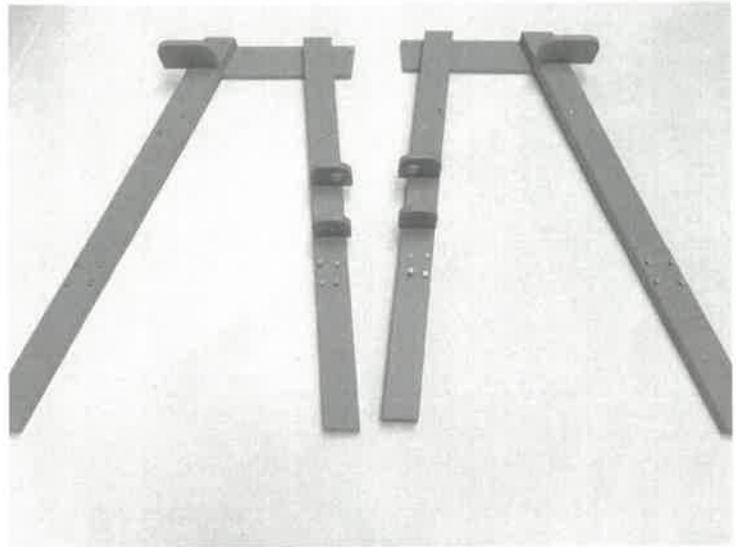
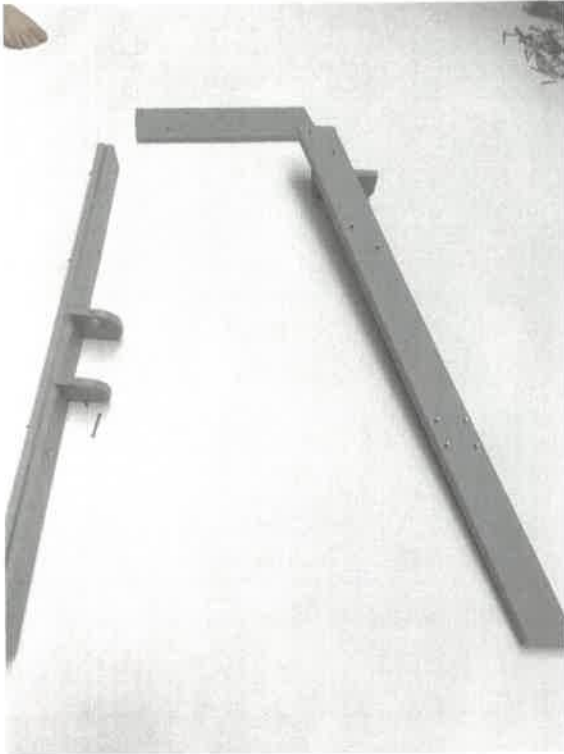

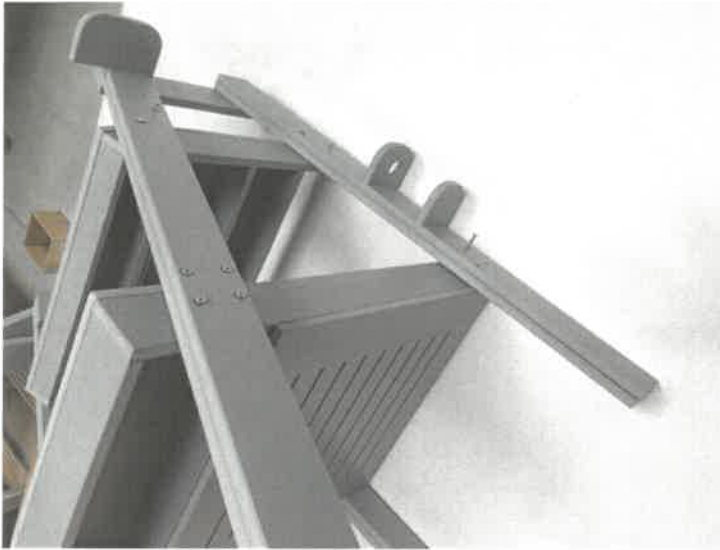

Montage rugleuning en armsteunen :





Montage voetsteunen :

